

Introduction To Temperature Controllers



The Miniature CN77000 is a full featured microprocessor-based controller in a 1/16 DIN package.

How Can I Control My Process Temperature Accurately and Reliably?

To accurately control process temperature without extensive operator involvement, a temperature control system relies upon a controller, which accepts a temperature sensor such as a thermocouple or RTD as input. It compares the actual temperature to the desired control temperature, or setpoint, and provides an output to a control element.

The controller is one part of the entire control system, and the whole system should be analyzed in selecting the proper controller. The following items should be considered when selecting a controller:

1. Type of input sensor (thermocouple, RTD) and temperature range
2. Type of output required (electromechanical relay, SSR, analog output)
3. Control algorithm needed (on/off, proportional, PID)
4. Number and type of outputs (heat, cool, alarm, limit)

What Are the Different Types of Controllers, and How Do They Work?

There are three basic types of controllers: on-off, proportional and PID. Depending upon the system to be controlled, the operator will be able to use one type or another to control the process.

On/Off

An on-off controller is the simplest form of temperature control device. The output from the device is either on or off, with no middle state. An on-off controller will switch the output only when the temperature crosses the setpoint. For heating control, the output is on when the temperature is below the setpoint, and off above setpoint.

Since the temperature crosses the setpoint to change the output state, the process temperature will be cycling continually, going from below setpoint to above, and back below. In cases where this cycling occurs rapidly, and to prevent damage to contactors and valves, an on-off differential, or "hysteresis," is added to the controller operations. This differential requires that the temperature exceed setpoint by a certain amount before the output will turn off or on again. On-off differential prevents the output from "chattering" (that is, engaging in fast, continual switching if the temperature's cycling above and below the setpoint occurs very rapidly).

On-off control is usually used where a precise control is not necessary, in systems which cannot handle the energy's being turned on and off frequently, where the mass of the system is so great that temperatures change extremely slowly, or for a temperature alarm.

One special type of on-off control used for alarm is a limit controller. This controller uses a latching relay, which must be manually reset, and is used to shut down a process when a certain temperature is reached.

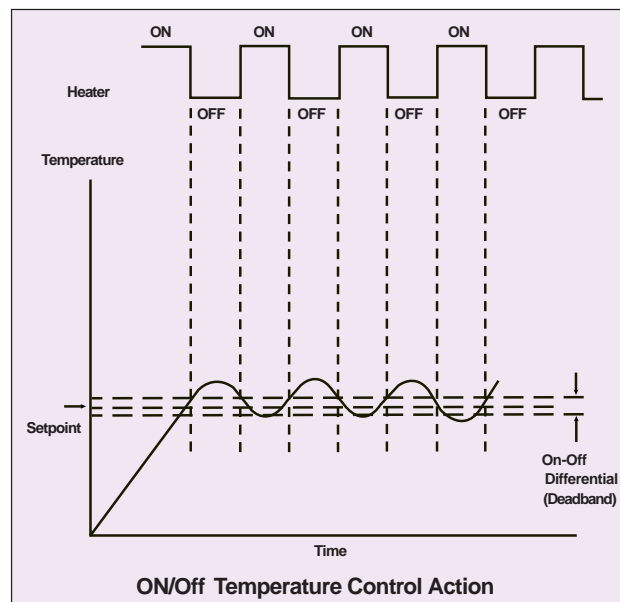

Introduction To Temperature Controllers cont'd

Proportional

Proportional controls are designed to eliminate the cycling associated with on-off control. A proportional controller decreases the average power being supplied to the heater as the temperature approaches setpoint. This has the effect of slowing down the heater, so that it will not overshoot the setpoint but will approach the setpoint and maintain a stable temperature. This proportioning action can be accomplished by turning the output on and off for short intervals. This "time proportioning" varies the ratio of 'on' time to 'off' time to control the temperature. The proportioning action occurs within a "proportional band" around the setpoint temperature. Outside this band, the controller functions as an on-off unit, with the output either fully on (below the band) or fully off (above the band). However, within the band, the output is turned on and off in the ratio of the measurement difference from the setpoint. At the setpoint (the midpoint of the proportional band), the output on:off ratio is 1:1; that is, the on-time and off-time are equal. If the temperature is further from the setpoint, the on- and off-times vary in proportion to the

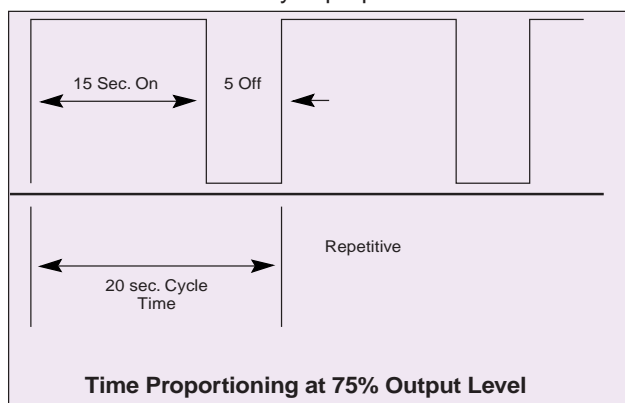

The CN2010 controller features ramp and soak, the ability to control temperature over time.

temperature difference. If the temperature is below setpoint, the output will be on longer; if the temperature is too high, the output will be off longer.

The proportional band is usually expressed as a percent of full scale, or degrees. It may also be referred to as gain, which is the reciprocal of the band. Note, that in time proportioning control, full power is applied to the heater, but is cycled on and off, so the average time is varied. In most units, the cycle time and/or proportional band are adjustable, so that the controller may better match a particular process.

In addition to electromechanical and solid state relay outputs, proportional controllers are also available with proportional analog outputs, such as 4 to 20 mA or 0 to 5 Vdc. With these outputs, the actual output level is varied, rather than the on and off times, as with a relay output controller.

One of the advantages of proportional control is simplicity of operation. It may require an operator to make a small adjustment (manual reset) to bring the temperature to setpoint on initial startup, or if the process conditions change significantly.

Time Proportional			Temp (°F)	4-20 mA Proportional	
Percent On	On Time Seconds	Off Time Seconds		Output Level	Percent Output
0.0	0.0	20.0	over 540	4 mA	0.0
0.0	0.0	20.0	540.0	4 mA	0.0
12.5	2.5	17.5	530.0	6 mA	12.5
25.0	5.0	15.0	520.0	8 mA	25.0
37.5	7.5	12.5	510.0	10 mA	37.5
50.0	10.0	10.0	500.0	12 mA	50.0
62.5	12.5	7.5	490.0	14 mA	62.5
75.0	15.0	5.0	480.0	16 mA	75.0
87.5	17.5	2.5	470.0	18 mA	87.5
100.0	20.0	0.0	460.0	20 mA	100.0
100.0	20.0	0.0	under 460	20 mA	100.0

Proportional Bandwidth

Example: heating

Setpoint: 500°F

Proportional Band: 80°F
(±40°F)

Systems that are subject to wide temperature cycling will also need proportional controllers. Depending upon the process and the precision required, either a simple proportional control or one with PID may be required.

Processes with long time lags and large maximum rate of rise (*e.g.*, a heat exchanger), require wide proportional bands to eliminate oscillation. The wide band can result in large offsets with changes in the load. To eliminate these offsets, automatic reset (integral) can be used. Derivative (rate) action can be used on processes with long time delays, to speed recovery after a process disturbance.

There are also other features to consider when selecting a controller. These include auto- or self-tuning, where the instrument will automatically calculate the proper proportional band, rate and reset values for precise control; serial communications, where the unit can “talk” to a host computer for data storage, analysis, and tuning; alarms, that can be latching (manual reset) or non-latching (automatic reset), set to trigger on high or low process temperatures or if a deviation from setpoint is observed; timers/event indicators which can mark elapsed time or the end/beginning of an event. In addition, relay or triac output units can be used with external switches, such as SSR solid state relays or magnetic contactors, in order to switch large loads up to 75 A.

PID

The third controller type provides proportional with integral and derivative control, or PID. This controller combines proportional control with two additional adjustments, which helps the unit automatically compensate for changes in the system. These adjustments, integral and derivative, are expressed in

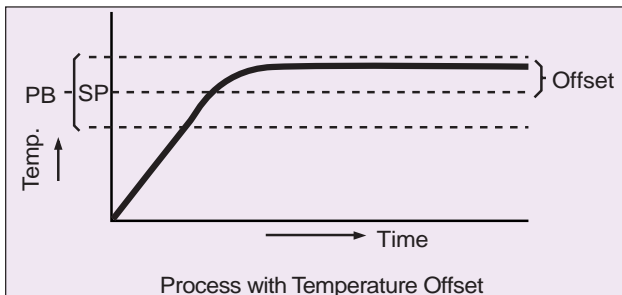

time-based units; they are also referred to by their reciprocals, RESET and RATE, respectively.

The proportional, integral and derivative terms must be individually adjusted or “tuned” to a particular system, using a “trial and error” method. It provides the most accurate and stable control of the three controller types, and is best used in systems which have a relatively small mass, those which react quickly to changes in energy added to the process. It is recommended in systems where the load changes often, and the controller is expected to compensate automatically due to frequent changes in setpoint, the amount of energy available, or the mass to be controlled.

What Do Rate and Reset Do, and How Do They Work?

Rate and reset are methods used by controllers to compensate for offsets and shifts in temperature. When using a proportional controller, it is very rare that the heat input to maintain the setpoint temperature will be 50%; the temperature will either increase or decrease from the setpoint, until a stable temperature is obtained. The difference between this stable temperature and the setpoint is called offset. This offset can be compensated for manually or automatically. Using manual reset, the user will shift the proportional band so that the process will stabilize at the setpoint temperature. Automatic reset, also known as integral, will integrate the deviation signal with respect to time, and the integral is summed with the deviation signal to shift the proportional band. The output power is thus automatically increased or decreased to bring the

process temperature back to setpoint,

The rate or derivative function provides the controller with the ability to shift the proportional band, to compensate for rapidly changing temperature. The amount of shift is proportional to the rate of temperature change.

A PID, or three-mode controller, combines the proportional, integral (reset) and derivative (rate) actions, and is usually required to control difficult processes. These controllers can also be made with two proportional outputs, one for heating and another for cooling. This type of controller is required for processes which may require heat to start up, but then generate excess heat at some time during operation.

What are the Different Output Types That Are Available for Controllers?

The output from the controller may take one of several forms. The most common forms are time proportional and analog proportional. A time proportional output applies power to the load for a percentage of a fixed cycle time. For example, with a 10 second cycle time, if the controller output were set for 60%, the relay would be energized (closed, power applied) for 6 seconds, and de-energized (open, no power applied) for 4 seconds. Time proportional outputs are available in three different forms: electromechanical relay, triac or ac solid state relay, or a dc voltage pulse (to drive an external solid state relay). The electromechanical relay is generally the most economical type, and is usually chosen on systems with cycle times greater than 10 seconds, and relatively small loads.

An ac solid state relay or dc voltage pulse are chosen for reliability, since they contain no moving parts. Recommended for processes requiring short cycle times, they need an additional relay, external to the controller, to handle the typical load required by a heating element. These external solid state relays are usually used with an ac control signal for ac solid state relay output controllers, or with a dc control signal for dc voltage pulse output controllers.

An analog proportional output is usually an analog voltage (0 to 5 Vdc) or current (4 to 20 mA). The output level from this output type is also set by the controller; if the output were set at 60%, the output level would be 60% of 5 V, or 3 V. With a 4 to 20 mA output (a 16 mA span), 60% is equal to $(0.6 \times 16) + 4$, or 13.6 mA. These controllers are usually used with proportioning valves or power controllers.

What Should I Consider When Selecting a Controller for My Application?

When you choose a controller, the main considerations include the precision of control that is necessary, and how difficult the process is to control. For easiest tuning and lowest initial cost, the simplest controller which will produce the desired results should be selected.

Simple processes with a well matched heater (not over- or undersized) and without rapid cycling can possibly use on-off controllers. For those systems subject to cycling, or with an unmatched heater (either over- or undersized), a proportional controller is needed.



Temperature Controllers

Selection Considerations

CONTROLLABILITY OF ELECTRIC HEAT

The basic function of a controller is to compare the actual temperature with its setpoint and produce an output that will maintain the setpoint.

The controller is one part of the entire control system, and the whole system should be analyzed in selecting the proper controller. The following items should be considered when selecting a controller.

1. Type of input sensor (thermocouple, RTD, card, and temperature range)
2. Placement of sensor
3. Control algorithm needed (on/off, proportional, PID, autotune PID)
4. Type of output hardware required (electromechanical relay, SSR, analog output signal)
5. Additional outputs or requirements of system (display required of temperature and/or setpoint, cooling outputs, alarms, limit, computer communication, etc.)

TYPE OF INPUT

The type of input sensor will depend on the temperature range required, the resolution and accuracy of the measurement required, and how and where the sensor is to be mounted.

PLACEMENT OF THE SENSOR

The correct placement of the sensing element with respect to the work and heat source is of the utmost importance for good control. If all three can be located in close proximity, a high degree of accuracy, up to the limit of the controller, is relatively easy to achieve. However, if the heat source is located some distance from the work, widely different accuracies can be obtained just by locating the sensing element at various places between the heater and the work.

Before selecting the location for the sensing element, determine whether the heat demand will be predominantly steady or variable. If the heat demand is relatively steady, placement of the sensing element near the heat source will hold the temperature change at the work to a minimum.

On the other hand, placing the sensing element near the work, when heat demand is variable, will enable it to more quickly sense a change in heat requirements. However, because of the increase in thermal lag between the heater and the sensing elements, more overshoot and undershoot can occur, causing a greater spread between maximum and minimum temperature. This spread can be reduced by selecting a PID controller.

CONTROL ALGORITHM (MODE)

This refers to the method in which the controller attempts to restore system temperature to the desired level. The two most common methods are two-position (on-off) and proportioning (throttling) controls.

ON/OFF CONTROL

On/off control has the simplest of control modes. It has a deadband (differential) expressed as a percentage of the input span. The setpoint is usually in the center of the deadband. Therefore, if the input is 0 to 1000°F, the deadband is 1% and the setpoint is set at 500°F, the output will be full on when the temperature is 495°F or below and will stay full on until the temperature reaches 505°F, at which time the output will be full off. It will stay full off until the temperature drops to 495°F.

If the process has a fast rate of response, the cycling between 495 and 505°F will be fast. The faster the rate of response of the process, the greater the overshoot and undershoot and the faster the cycling of the contactor when used as a final control element.

On/off control is usually used where a precise control is not necessary, for example, in systems that cannot handle having the energy turned on and off frequently, where the mass of the system is so great that the temperature changes extremely slowly, or for a temperature alarm.

One special type of on/off control used for alarm is a limit controller. This controller uses a latching relay, which must be manually reset, and is used to shut down a process when a certain temperature is reached.

PROPORTIONAL

Proportional controls are designed to eliminate the cycling associated with on/off control. A proportional controller decreases the average power being supplied to the heater as the temperature approaches setpoint. This has the effect of slowing down the heater so that it will not overshoot the setpoint, but will approach the setpoint and maintain a stable temperature. This proportioning action can be accomplished by turning the output on and off for short intervals. This "time proportioning" varies the ratio of "on" time to "off" time to control the temperature.

The time period between two successive turn-ons is known as the "cycle time" or "duty cycle." The proportioning action occurs within a "proportional band" around the setpoint temperature. Outside this band, the controller functions as an on/off unit, with the output either fully on (below the band) or fully off (above the band). However, within the band,

output is turned on and off in the ratio of the measurement difference from the setpoint. At the setpoint (the midpoint of the proportional band), the output on/off ratio is 1:1, that is, the on-time and off-time are equal. If the temperature is further from the setpoint, the on- and off-times vary in proportion to the temperature difference. If the temperature is below setpoint, the output will be on longer. If the temperature is too high, the output will be off longer.

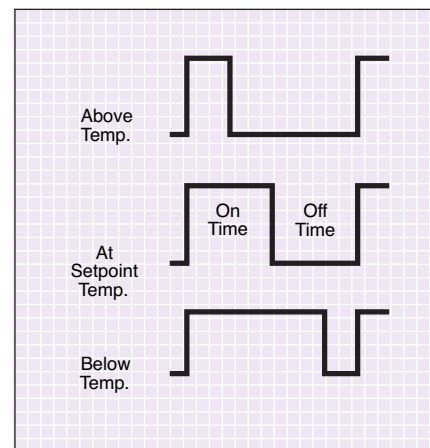

Figure 1: Proportional control

The proportional band is usually expressed as a percentage of full input range scale, or in degrees. It may also be referred to as gain, which is the reciprocal of the band. In many units, the cycle time and/or proportional bandwidth are adjustable, so that the controller can be better matched to a particular process.

Proportional controllers have a manual reset (trim) adjustment, which can be used to adjust for an offset between the steady state temperature and the setpoint.

In addition to electromechanical and solid state relay outputs, proportional controllers are also available with proportional analog signal outputs, such as 4 to 20 mA or 0 to 5 Vdc. With these outputs, the actual output level amplitude is varied, rather than the proportion of on and off times.

PROPORTIONAL PLUS INTEGRAL PLUS DERIVATIVE CONTROL MODE (PID):

This controller operates the same way a proportional controller does, except that the function of the trim adjustment is performed automatically by the integral function (automatic reset). Thus, load changes are compensated for automatically and the temperature agrees with the setpoint under all operating conditions. Offset is eliminated.

Temperature Controllers

Selection Considerations

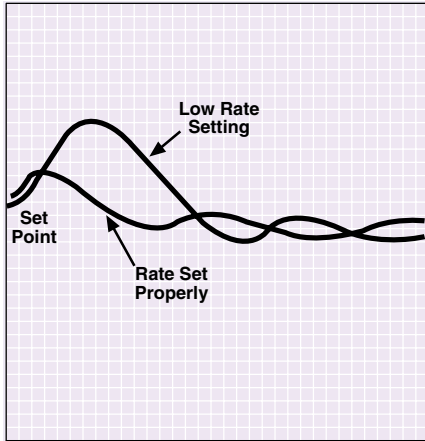

Figure 2: Rate function compensates for rapid changes.

The derivative function (rate action) compensates for load changes which take place rapidly. An example is a traveling belt oven where the product is fed intermittently. When the product enters the oven, there is a sharp rise in the demand for heat, and when it stops, there is an excess of heat. Derivative action reduces the undershoot and overshoot of temperature under these conditions and prevents bad product due

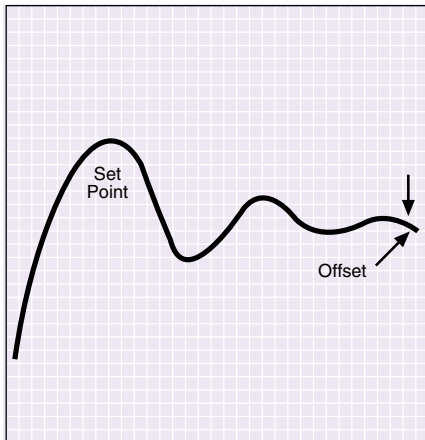

Figure 3: Reset function eliminates offset.

to over or under curing.

PID control provides more accurate and stable control than on/off or proportional controller types. It is best used in systems that have a relatively small mass and which react quickly to changes in energy added to the process. It is recommended in systems where the load changes often. The controller is expected to automatically compensate the amount of energy available or the mass to be controlled, due to frequent changes in setpoint.

The proportional, integral and derivative

terms must be “tuned,” *i.e.*, adjusted to a particular process. This is done by trial and error. Some controllers called Autotune controllers attempt to adjust the PID parameters automatically.

TYPE OF CONTROL OUTPUT HARDWARE

The output hardware in a temperature controller may take one of several forms. Deciding on the type of control hardware to be used depends on the heater used and power available, the control algorithm chosen, and the hardware external to the controller available to handle the heater load. The most commonly used controller output hardware is as follows:

Time Proportional or On/Off

- 1) Mechanical Relay
- 2) Triac (ac solid state relay)
- 3) dc Solid State Relay Driver (pulse)

Analog Proportional

- 1) 4-20 mA dc
- 2) 0-5 Vdc or 0-10 Vdc

A time proportional output applies power to the load for a percentage of a fixed cycle time. For example, with a 10 second cycle time, if the controller output were set for 60%, the relay would be energized (closed, power applied) for 6 seconds, and de-energized (open, no power applied) for 4 seconds.

The electromechanical relay is generally the most economical output type, and is usually chosen on systems with cycle times greater than 10 seconds and relatively small loads.

Choose an ac solid state relay or dc voltage pulse to drive an external SSR with reliability, since they contain no moving parts. They are also recommended for processes requiring short cycle times. External solid state relays may require an ac or dc control signal.

An amplitude proportional output is usually an analog voltage (0 to 5 Vdc) or current (4 to 20 mA). The output level from this output type is also set by the controller. If the output were set at 60%, the output level would be 60% of 5 V, or 3 V. With a 4 to 20 mA output (a 16 mA span), 60% is equal to $(0.6 \times 16) + 4$, or 13.6 mA. These controllers are usually used with SCR power controllers or proportioning valves.

The power used by an electrical resistance heater will usually be given in watts. The capacity of a relay is given in amps. A common formula to determine the safe relay rating requirements is:

$$W = V(A)(1.5) \text{ or } A = W/(V)(1.5)$$

Where A = relay rating in amps

W = heater capacity in watts

V = voltage used

1.5 = safety factor

The types of hardware available, external to the controller, to allow it to handle the load, are as follows:

- 1) Mechanical Contactor
- 2) ac controlled solid state relay
- 3) dc controlled solid state relay
- 4) Zero crossover SCR power controller
- 5) Phase angle fired SCR power controller

Mechanical contactors are external relays, which can be used when a higher amperage than can be handled by the relay in the controller is required, or for some three-phase systems. They are not recommended for cycle times shorter than 15 seconds.

Solid state relays have the advantage over mechanical contactors, in that they have no moving parts, and thus can be used with short cycle times. The shorter the cycle time, the less dead lag and the better the control. The “switching” takes place at the zero voltage crossover point of the alternating current cycle; thus, no appreciable electrical noise is generated. An ac controlled solid state relay is used with either a mechanical relay or triac output from the controller, and is available for currents up to 90 amps at voltages of up to 480 Vac. DC solid state relays are used with dc solid state driver (pulse) outputs. The “turn on” signal can be from 3 to 32 Vdc and models are available to control up to 90 amps at up to 480 Vac.

Zero crossover SCR power controllers are used to control single or three-phase power for even larger loads. They can be used for currents up to 200 amps at 480 volts. A 4-20 mA dc control signal is usually required from the controller. The zero crossover SCR power controllers convert the analog output signal to a time proportional signal with a cycle time of about two seconds or less, and also provide switching at the zero crossover point to avoid generating electrical noise.

Phase angle SCR power controllers also are operated by a 4-20 mA dc controller output. Power to the load is controlled by governing the point of turn on (firing) of each half cycle of a full ac sine wave. This has the effect of varying the voltage within a single 0.0167 second period. By comparison, time proportional controllers vary the average power over the cycle time, usually more than 1 second, and often more than 15 seconds. Phase angle SCR's are only recommended for low mass heating elements such as infrared lamps or hot wire heaters. 



UNITED STATES

www.omega.com
1-800-TC-OMEGA
Stamford, CT.

CANADA

www.omega.ca
Laval(Quebec)
1-800-TC-OMEGA

GERMANY

www.omega.de
Deckenpfronn, Germany
0800-8266342

UNITED KINGDOM

www.omega.co.uk
Manchester, England
0800-488-488

FRANCE

www.omega.fr
Guyancourt, France
088-466-342

CZECH REPUBLIC

www.omegaeng.cz
Karviná, Czech Republic
596-311-899

BENELUX

www.omega.nl
Amstelveen, NL
0800-099-33-44



More than 100,000 Products Available!

• Temperature

Calibrators, Connectors, General Test and Measurement Instruments, Glass Bulb Thermometers, Handheld Instruments for Temperature Measurement, Ice Point References, Indicating Labels, Crayons, Cements and Lacquers, Infrared Temperature Measurement Instruments, Recorders Relative Humidity Measurement Instruments, RTD Probes, Elements and Assemblies, Temperature & Process Meters, Timers and Counters, Temperature and Process Controllers and Power Switching Devices, Thermistor Elements, Probes and Assemblies, Thermocouples Thermowells and Head and Well Assemblies, Transmitters, Wire

• Flow and Level

• pH and Conductivity

Conductivity Instrumentation, Dissolved Oxygen Instrumentation, Environmental Instrumentation, pH Electrodes and Instruments, Water and Soil Analysis Instrumentation

• Data Acquisition

Auto-Dialers and Alarm Monitoring Systems, Communication Products and Converters, Data Acquisition and Analysis Software, Data Loggers Plug-in Cards, Signal Conditioners, USB, RS232, RS485 and Parallel Port Data Acquisition Systems, Wireless Transmitters and Receivers

• Pressure, Strain and Force

Displacement Transducers, Dynamic Measurement Force Sensors, Instrumentation for Pressure and Strain Measurements, Load Cells, Pressure Gauges, Pressure Reference Section, Pressure Switches, Pressure Transducers, Proximity Transducers, Regulators, Strain Gages, Torque Transducers, Valves

• Heaters

Band Heaters, Cartridge Heaters, Circulation Heaters, Comfort Heaters, Controllers, Meters and Switching Devices, Flexible Heaters, General Test and Measurement Instruments, Heater Hook-up Wire, Heating Cable Systems, Immersion Heaters, Process Air and Duct, Heaters, Radiant Heaters, Strip Heaters, Tubular Heaters